

FRONT ELEVATION

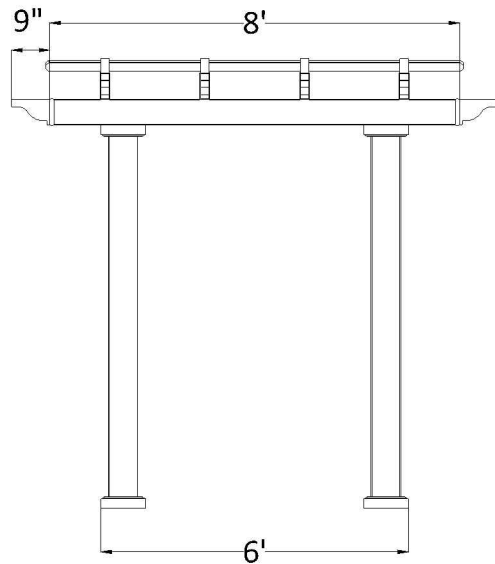

POST ON CENTER MEASUREMENT

POST STYLE	INCHES
5" Square Post (7" base)	67
7" Square Column (10 1/2" base)	61 1/2
7" Round Column (10 1/2" base)	61 1/2
10" Round Column (12 1/4" base)	59 3/4

SIDE ELEVATION

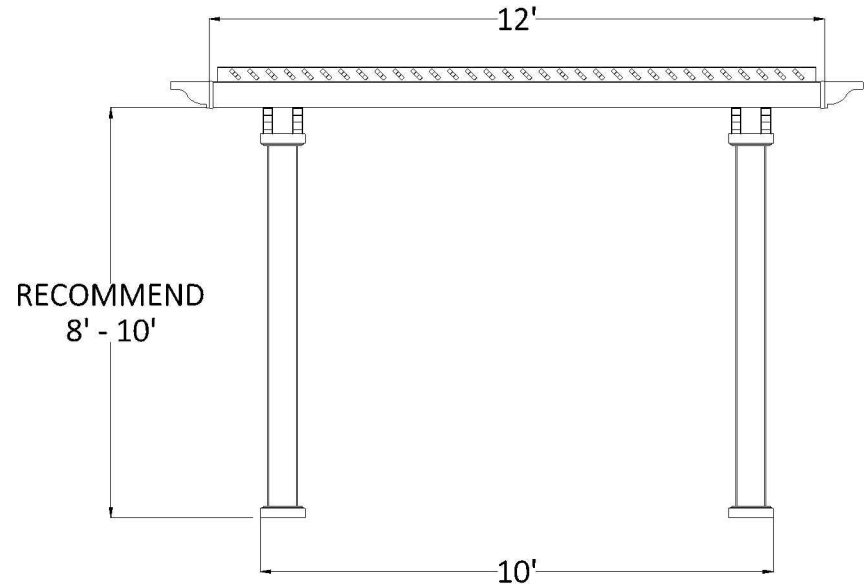

POST ON CENTER MEASUREMENT

POST STYLE	INCHES
5" Square Post (7" base)	115
7" Square Column (10 1/2" base)	109 1/2
7" Round Column (10 1/2" base)	109 1/2
10" Round Column (12 1/4" base)	107 3/4

PLAN VIEW

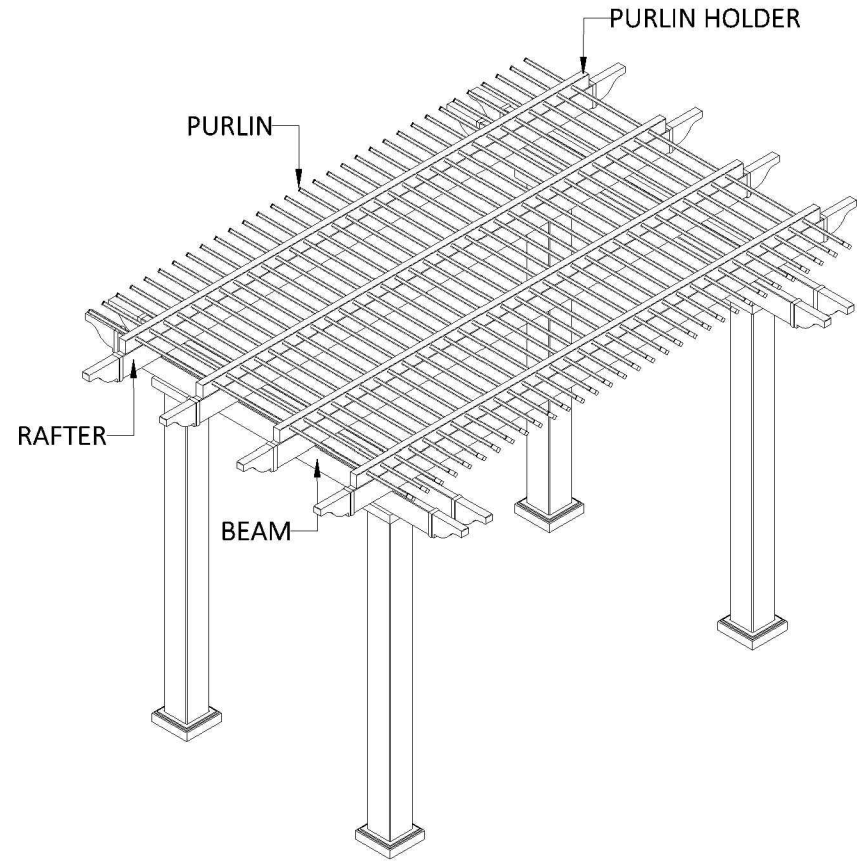
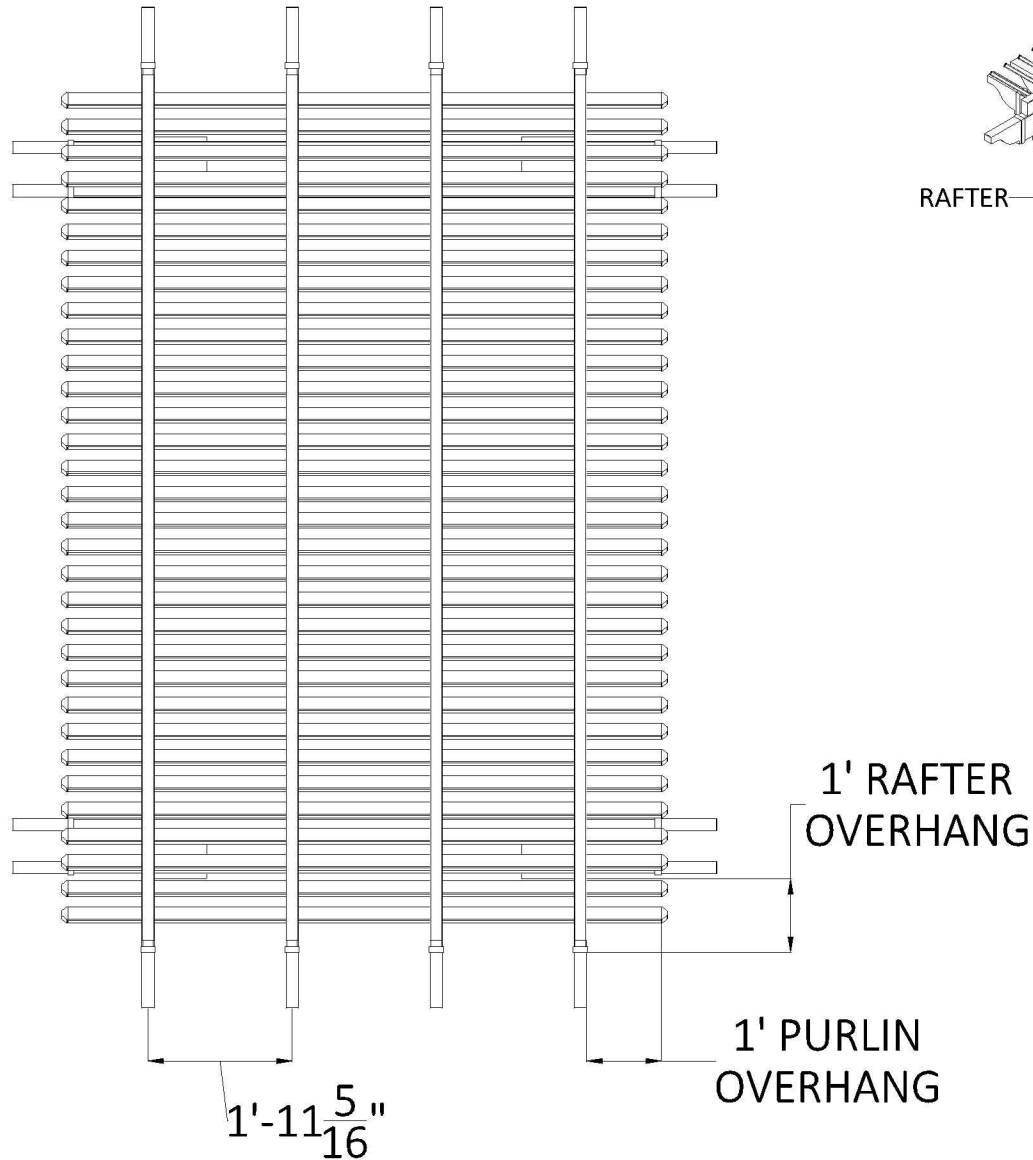

KIT COMPONENTS

DESCRIPTION	QUANTITY
Your Selected Post with Aluminum Insert	4
2 X 6 Beam with Aluminum Insert	4
2 X 6 Rafter with Aluminum Insert	4
2 X 6 Pergola Cap	16
2 X 3 1/2 Purlin Holder	4
2 X 3 1/2 Flat Cap	8
7/8 X 3 Purlin (75% Shade)	34
7/8 X 3 Purlin Cap	68

12' x 8' FREESTANDING PERGOLA

Heartlandpergolas.com

563-345-6745

